

► Injection with Acrylate Gel

Sealing of Structural Elements with Ground Contact

WEBAC®



All the data indicated above are of an advisory nature representing our current state of knowledge and in no way binding, information provided in this respect by our employees is also non-binding. As the exact chemical, technical and physical conditions of the actual application are beyond WEBAC's control, this information does not preclude examination of the products and procedures for the intended application by the user. WEBAC is thus unable to guarantee results. The user is fully responsible for compliance with any existing regulations and restrictions when using the products. With publication of this brochure all previous versions are no longer valid. Copyright by WEBAC-Chemie GmbH. No parts of this brochure may be reproduced and/or printed without the prior written permission of WEBAC-Chemie GmbH. Version 12/23

Contents

Introduction	Moisture Ingress into the Structure	2
	Applications for acrylate gels	
	Injections with Acrylate Gels	3
Norms and Guidelines	Different Applications – Different Rules	4
Determination of the Actual Condition	Building Condition Analysis	5–6
Product Range	Acrylate Gels	7
	Packers	8
	Positioning and distances of the packers	
	Pumps	9
Occupational Safety	Protective Equipment and First Aid	10
	Personal protective equipment and safety measures	
	First aid	
Execution/Application	Curtain Injection	11
	Joint Sealing	12
Environmental Protection	Disposal	13
	General notes on disposal	

Introduction

Moisture Ingress into the Structure

Water and substances that are harmful to the structure (e. g. chlorides) can penetrate the building through cavities, joints and defective building sealings and cause moisture penetration or damage to the building structure.

Post-construction sealing of building components in contact with the ground against moisture using conventional methods can be very complex. Waterproofing with acrylate gels enables cost-effective waterproofing solutions even for difficult building structures.

Expert planning and the selection of a suitable injection system are prerequisites for the successful implementation of the repair measure and thus enable a longer service life of the structures. Demolition or replacement construction is not necessary, which saves resources and ultimately benefits the environment.

Applications for acrylate gels

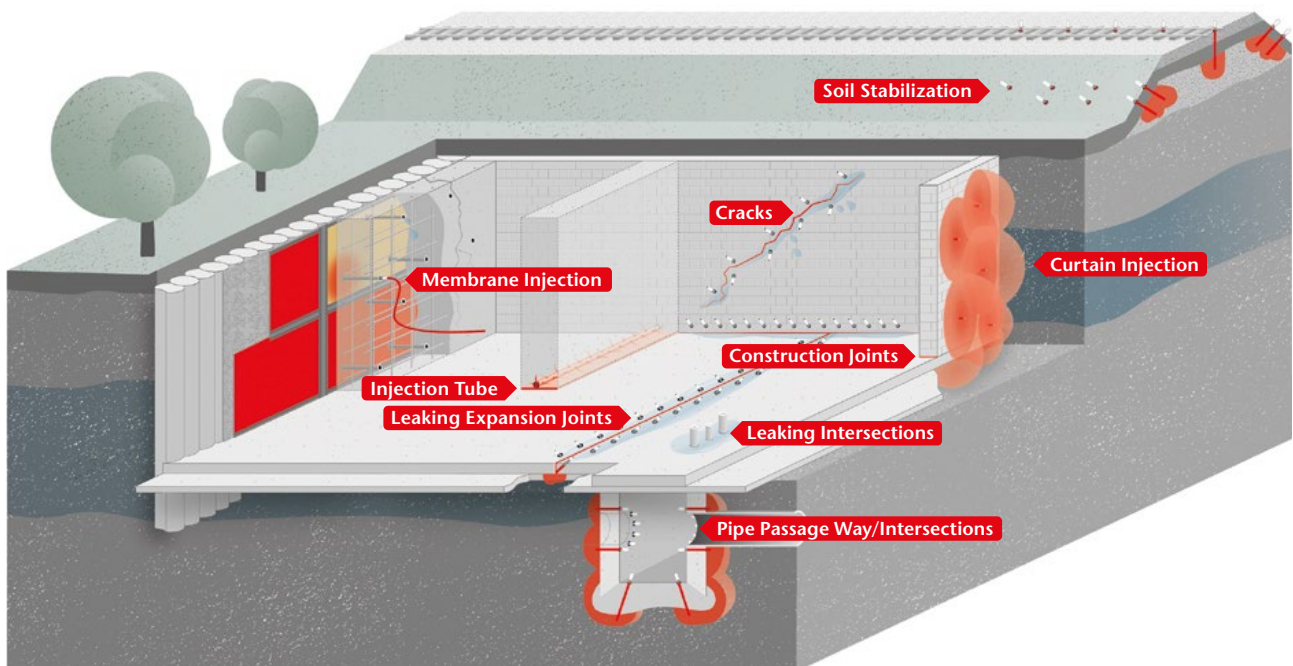

Introduction

Injection with Acrylate Gels

Sealants with acrylate gels have become established over the years and are used when:

- The adjacent development or use of the area to be repaired precludes exposure of the surfaces,
- The area to be sealed is no longer accessible,
- The traffic conditions do not allow the repair area to be closed,
- A construction method that is gentle on operations is required,
- Or if, based on the cost calculation, the costs of the accompanying work (high earth fillings, complex excavation pit shoring, bypasses, etc.) are disproportionately high.

Before applying a gel injection, the conventional repair options or renewal must be examined and evaluated.

Theoretical effective range of gel injection into the subsoil

Injections to stabilize the subsoil and prevent subsidence can be carried out either in advance of a new construction project or post-construction. In order to carry out this work successfully, a subsoil survey is required, which is prepared with the help of a geologist in order to obtain the most accurate information possible about the soil properties.

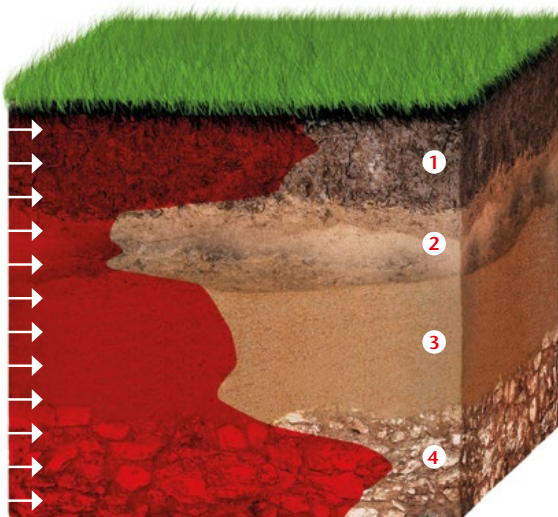

- 1: rough sand
- 2: clay/silt
- 3: fine sand
- 4: rough gravel/sand



Gel-sand-curtain behind the component

Different Applications – Different Rules

Acrylate gels are used in many areas. The rules and norms that apply in these areas are just as varied as the areas of application.

Application	Rules and regulations
Sealing outside the component "Curtain Injection"	<ul style="list-style-type: none"> • Approval by DIBt (German Institute for Building Technology) e. g. National technical approval (abZ)/general construction technique permit (aBG) • Injections into the subsoil are subject to approval and must be reported to the lower water authority (based on Water Resources Act § 8 ff – Approved injection substances) • WTA Code of Practice 5-20-09-D – Gel injection
Sealing in building components "Damp-proof course"	<ul style="list-style-type: none"> • WTA Code of Practice 4-6-98-D – Subsequent sealing of components in contact with the ground
Sealing of structural joints "Joint Sealing"	<ul style="list-style-type: none"> • ABI Code of Practice 3rd edition STUVA (Research Association for Tunnels and Transportation Facilities – STUVA – e. V.) – Sealing of buildings by injection
Injection of concrete components "Crack Injection"	<ul style="list-style-type: none"> • DIN EN 1504 part 5 "Injection of Concrete Structures"
Injection into the subsoil "Soil stabilization"	<ul style="list-style-type: none"> • Injections into the subsoil are subject to approval and must be reported to the lower water authority (basis Water Resources Act § 8 ff – Approved injection substances)

This table provides a brief overview, but does not claim to be exhaustive.

NOTE

Please observe the currently valid regulations and guidelines.



WEBAC® 240



WEBAC® 240 Bseal

Determination of the Actual Condition

Building Condition Analysis

In order for structural components to be refurbished to a high standard, an expert building state analysis must be carried out. This analysis is the first and most important step on the way to successful and sustainable sealing. It serves to record the current condition of the building component, the subsoil or the joint and to determine suitable measures.

The analysis should determine important parameters such as:

- Causes of moisture penetration
- Type of component, building materials used (concrete, brick, etc.)
- Component structure (wall structure, cavities, penetrations, etc.) – Determination by core drilling if necessary
- Structure of the building backfill (subsoil exploration at the building)

These values provide initial information about:

- Cavity content (pore volume) of the soil
- Grading curve
- Water content and groundwater level
- pH value and possible pollutant load
- Soil structure (soil profile)

Based on these results, initial planning can take place, e.g.:

- Determination:
 - Areas to be repaired
 - Material requirements
 - Preparatory work (e.g. protective measures)
 - Implementation instructions (e.g. hole pattern)
- Observation of possible changes to the waterways during and after the restoration work
- Clarification of required official approvals
- Preparation of a cost calculation



Drill core removal

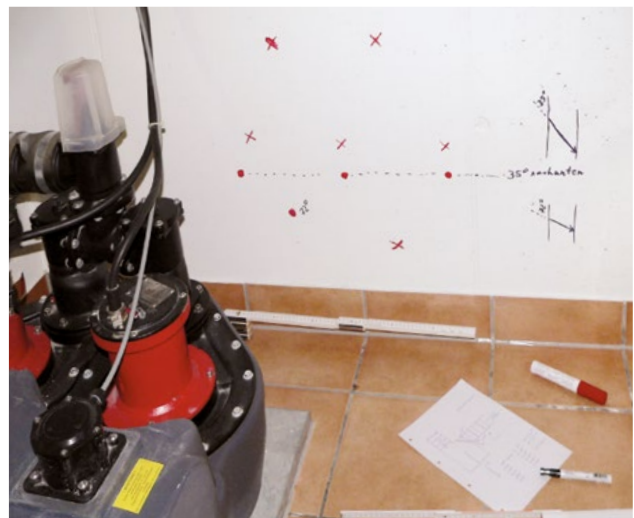

Expert planning (source: Deutscher Beton- und Bautechnik-Verein e. V.)

Determination of the Actual Condition

Building Condition Analysis

The following parameters should be determined when recording the current condition of expansion joints:

- Type of sealing elements and their position (internal or external)
- Joint width and depth
- Joint course
- Old joint fillings

Initial planning can then be carried out on the basis of the information obtained, such as:

- Selection of the impact profile or other options for joint limitation
- Planning the insulation of the joint areas
- Selection of the injection material (e.g. polymer-reinforced gel variant)
- Determination of the drill hole grid



Measurement of a brittle expansion joint



State of construction before renovation

Product Range

Acrylate Gels

Acrylate gels are usually 3- or 4-component injection materials with a very low viscosity. The materials are particularly suitable for sealing thicker masonry and, like PUR injection resins, have a capillary clogging effect. They can also be used with salt exposure and high moisture penetration of the component.

WEBAC offers a comprehensive and efficient product range for this purpose. Our products are suitable for repairing various mineral components in a wide range of moisture conditions and processing temperatures.

Different acrylate gels are used depending on the area of application.

Application	Explanation	Products
Sealing outside the building component "Curtain injection"	<ul style="list-style-type: none"> • Post-construction sealing of building components in contact with the ground by inserting a gel curtain between the ground and the building component • Mainly used when components cannot be sealed from the outside or can only be sealed with disproportionate effort 	WEBAC® 240
Sealing in the building component "Damp-proof course"	<ul style="list-style-type: none"> • The sealing effect is achieved by injecting the injection material into the porous building structure • Damp-proof courses in the masonry prevent moisture from the soil from rising capillary in the masonry • Vertical seals prevent moisture from penetrating over the surface 	WEBAC® 240 WEBAC® 250
Sealing of structural joints "Joint sealing"	<ul style="list-style-type: none"> • Defective structural and expansion joints can be subsequently sealed by backfilling/filling • Also suitable for the subsequent sealing of so-called "waterproof concrete tanking" in the event of incorrect installation of the planned joint seals 	WEBAC® 240 WEBAC® 240 + Bseal I
Injection of concrete components "Crack repair"	<ul style="list-style-type: none"> • Cracks are filled to prevent the ingress of corrosive substances 	WEBAC® 270 WEBAC® 240 + Bseal I
Injection into the subsoil "Consolidation grouting"	<ul style="list-style-type: none"> • Filling of cavities, fissure and pore systems to form a coherent injection body • Application examples: Slope protection and passages in microtunneling (sealing of start and target shafts) in tunnels and underground construction 	WEBAC® 240

Product Range

Packers

WEBAC hammer-in packers with button head fitting are used for the injection of WEBAC acrylate gels. Alternatively, WEBAC mechanical packers can also be used if the component is sufficiently strong. The mixing head of the injection pump is connected to the packer via a sliding coupling.

For cavity-rich or multi-layered masonry, it is recommended to use a packer extension to prevent the injection gel from flowing back into the cavity or the air layer to be bridged.

Various types of ram injection lances are used for ground injections.

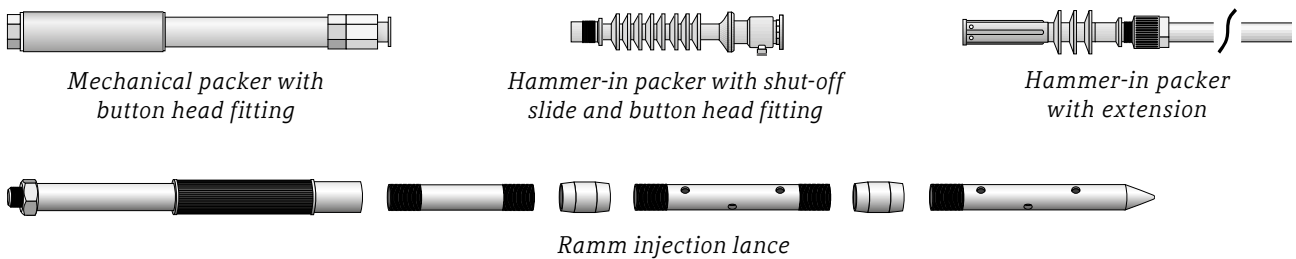

Positioning and distances of the packers

Curtain injection

As a rule, a staggered drill hole and row spacing of 30 to 50 cm is installed. The drill holes should be installed so that the effective zones overlap at all levels.

Rule of thumb: 7–10 packers/m²

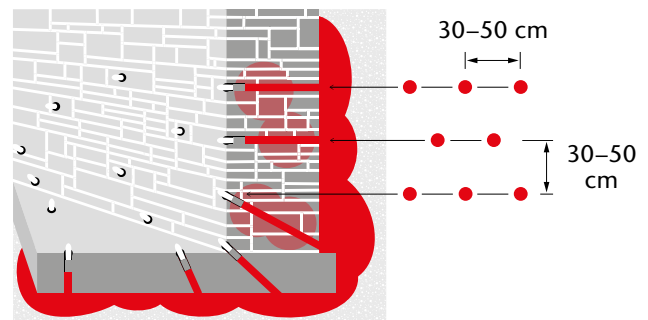

Joint sealing

Alternate drilling of the joint. The distance can be arranged depending on the circulation.

Rule of thumb: 8 packers/m

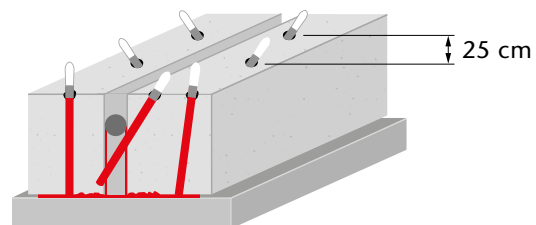

Surface injection

A standard distance of 10 to 12.5 cm has proven itself. For thicker masonry, a two-row packer arrangement ensures better distribution of the injection material.

Rule of thumb: 8–16 packers/m²

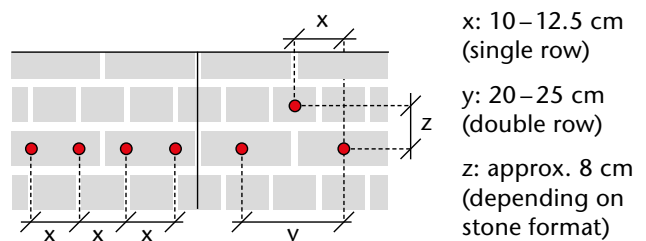

Product Range

Pumps

WEBAC® IP 2K-AG, compressed air-driven 2C pump, is used for processing acrylate gels.

The two components of the injection material are fed in separate hoses to the mixing head, where the material is mixed with a static mixer. A separate flushing pump cleans the mixing head with water. To operate the pump a compressor with an air volume of 300 – 400 l/min is required.

WEBAC® IP 2K-AG

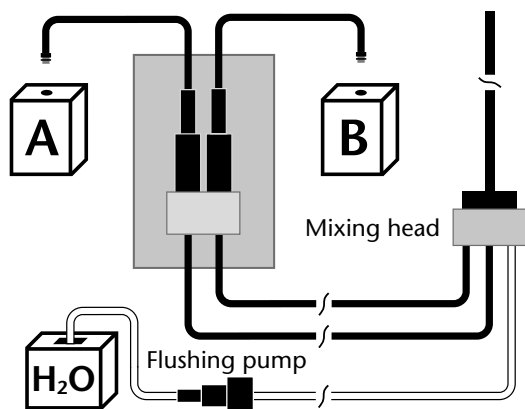
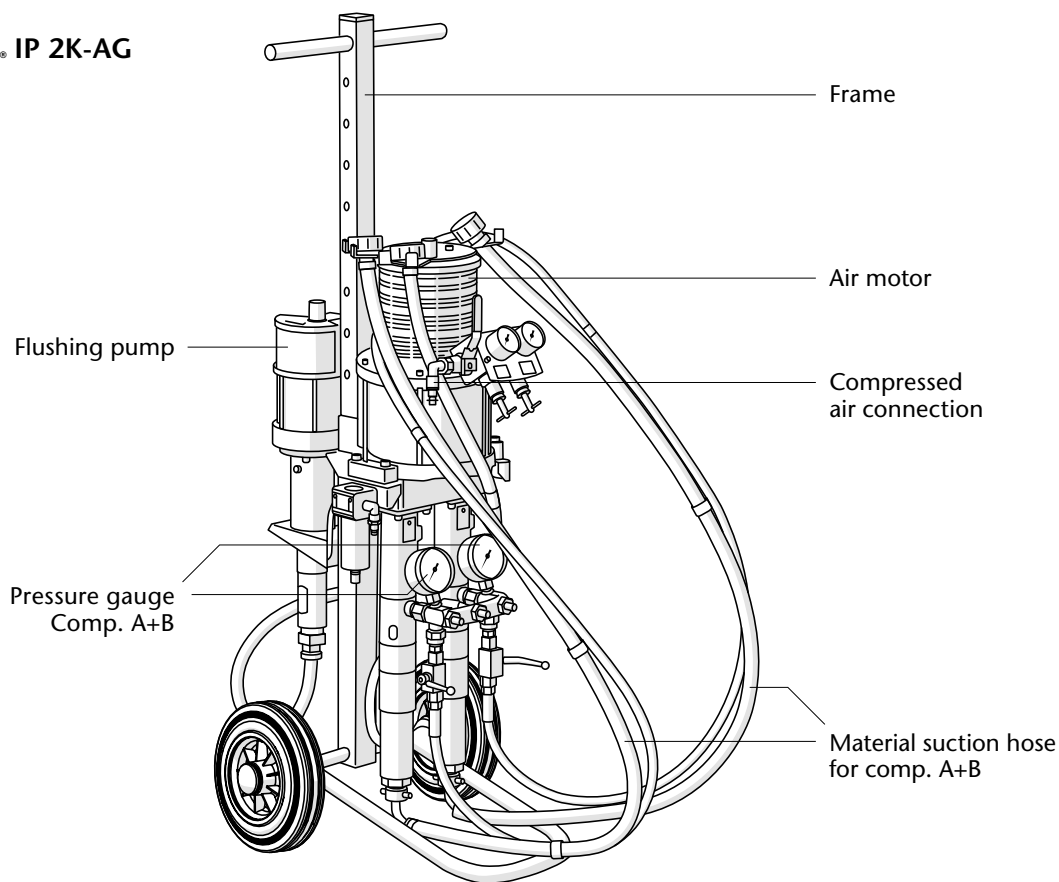

Diagram of an injection unit

NOTE

The injection pressure should always be kept as low as possible to avoid damage to or in the component!

Protective Equipment and First Aid

Personal protective equipment and safety measures

When handling and processing chemical products, risks and hazards can arise for your own health and the health of others.

Risks can be reduced and damage to health safely avoided by careful and conscientious work preparation and appropriate precautionary and protective measures.

To minimize the hazard potential for the user, knowledge of substance- and product-specific information is essential. Information on the substances used, including hazard and safety information and recommended personal protective equipment, can be found on the canister, in the Technical and Safety Data Sheets.



Based on this data, you can assess the risk for yourself and your colleagues. Take into account the typical contact routes such as inhalation, ingestion, as well as skin and eye contact and, if possible, take organizational protective measures in advance to reduce health hazards and thus contribute to safety on your construction site.

For example, ensure adequate ventilation when carrying out injection work in closed spaces. When handling chemical products, please wear suitable protective clothing with long trousers and long sleeves, protective gloves and goggles. Many construction sites also require safety shoes, high-visibility vest and helmet.

Observe general health and safety instructions on the construction site and keep escape and rescue routes clear. As a hygiene measure, be sure to wash your hands before breaks and at the end of work and ensure that the workplace is clean. Do not eat, drink or smoke during work.

Information and operating instructions for the safe handling of our products can be found in the in the GISCODES.

First aid

- After inhalation, if the person feels dizzy or unwell, he/she is advised to get fresh air and contact a doctor or the Poison Control Center.
- After eye contact, remove any contact lenses and gently flush eyes with plenty of water for about 15 minutes and seek medical attention. Use eye wash if available.
- After skin contact, clean the affected area thoroughly with plenty of water. In case of extensive contact, use emergency shower if necessary. Do not use solvents or thinners. Remove contaminated clothing immediately.

Curtain Injection



Fig. 1: Marking the drill hole grid, drill holes and place packers



Fig. 2: Example of packer positioning



Fig. 3: Injection from bottom to top



Fig. 4: Post-injection



Fig. 5: Removing packers – drilling out (at least 10 cm) and sealing drill holes



Fig. 6: Example of a gel curtain after injection

ORIENTATION VALUE

Material requirement
depending on soil conditions, etc.

Curtain injection
approx. 20–60 kg/m²

Joint Sealing



Fig. 1: Actual condition of joint before sealing



Fig. 2: Clearing joint, cleaning joint edges, cutting open joints if necessary



Fig. 3: Installing hammer-in profile

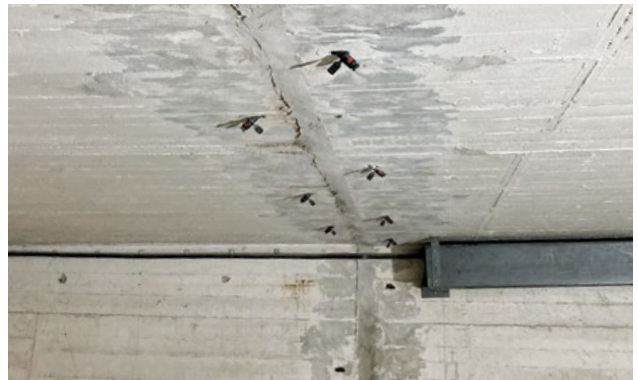

Fig. 4: Patching joint areas, drilling holes and installing packers



Fig. 5: Injecting material



Fig. 6: Reworking joint

RULE OF THUMB

Material requirement

for filling a cleared and prepared joint:

Joint depth x joint length x joint width = "theoretical" joint volume

Injection with Acrylate Gel

Disposal

General notes on disposal

Product residues (liquid or paste-like) from the building products area are special waste and must therefore be disposed by an approved waste management company, in accordance with the legal regulations and the requirements of the local/regional authorities.

Information on suitable waste disposal facilities and disposal routes can be obtained by the waste owner from the competent authority or from the regional offices.





WEBAC®

WEBAC-Chemie GmbH

Fahrenberg 22

22885 Barsbüttel/Hamburg, Germany

Tel. +49 40 67057-0 · Fax +49 40 6703227

info@webac.de · www.webac.de

www.webac-grouts.com



We are an associate member in DGB



DEUTSCHE BAUCHEMIE



Responsible-Care